



SPIDER LIFT



**BI-ENERGY**

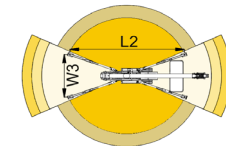
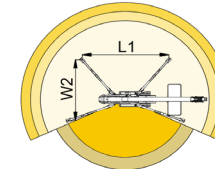
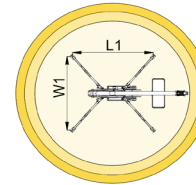
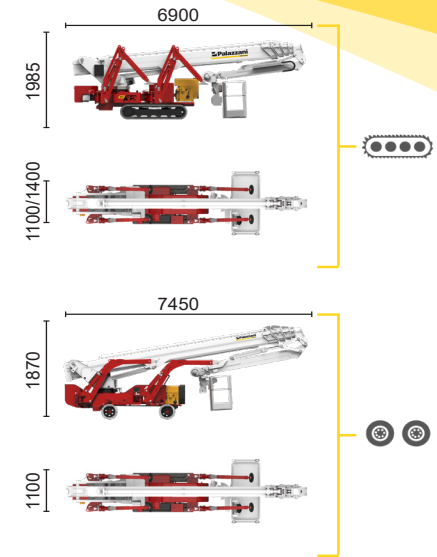
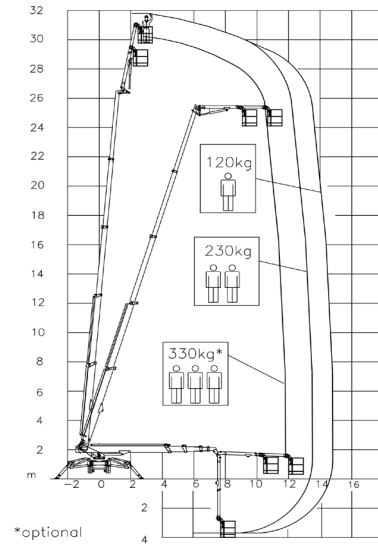
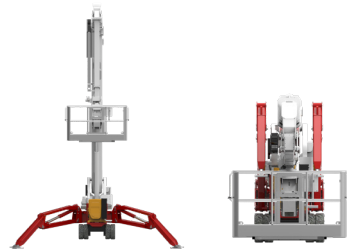

 Diesel  
18,2 kW

 Single-phase  
Electric motor  
230VAC - 3 kW



11,7 m	13,3 m	14,3 m	8,4 m	10 m	L1	L2	W1	W2	W3
330* kg	230 kg	120 kg	330* kg	120/230 kg	5125 mm	6460 mm	4760 mm	3785 mm	2820 mm



XTJ 32/C		32 m	14,3 m	330 kg*	660°	180x70 cm	90°+80°	2,82-4,76 m	16%	38%	3 km/h	5940 kg	35 kN	2,43 kN/m2	4,78 kN/m2
XTJ 32/R		32 m	14,3 m	330 kg*	660°	180x70 cm	90°+80°	2,82-4,76 m	16%	18%	2 km/h	5940 kg	35 kN	2,43 kN/m2	4,43 kN/m2

Available power options:

**BI-ENERGY** (DIESEL+AC)

**ECO** (AC+BATTERY)

Characteristics and technical data are informative only and subjected to change without notice.

Palazzani Industrie S.p.A.

Via del Pavione, 4 - 25050 - Paderno F.C. (BS) - Italy

Tel. (+39) 0306857073

info@palazzani.it

www.palazzani.it



NC 834 A 22



SPIDER LIFT

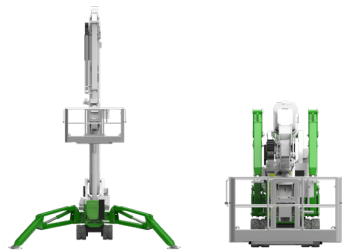

**ECO**

Single-phase  
Electric motor  
230VAC - 16 kW

Lithium iron  
phosphate battery  
LiFePO4  
48V - 315 Ah

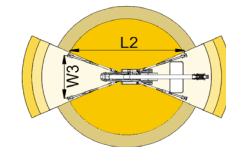
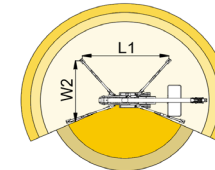
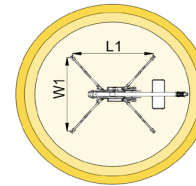
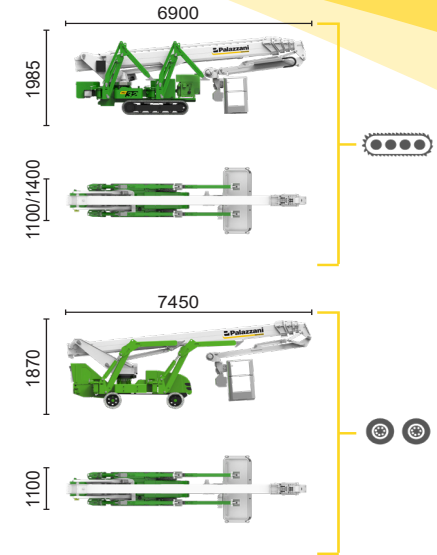
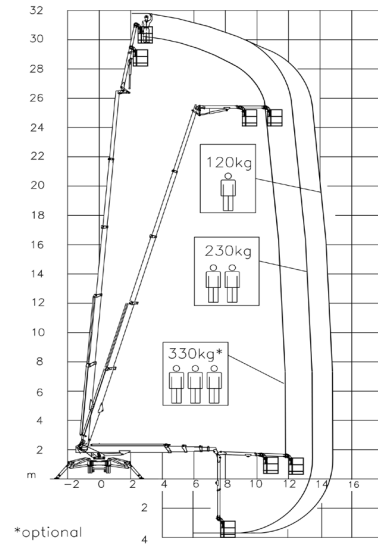

11,7 m	13,3 m	14,3 m	8,4 m	10 m	L1	L2	W1	W2	W3
330* kg	230 kg	120 kg	330* kg	120/230 kg	5125 mm	6460 mm	4760 mm	3785 mm	2820 mm

XTJ 32/C			32 m	14,3 m	330 kg*	660°	180x70 cm	90°+80°	2,82-4,76 m	16%	38%	1,2 km/h	5940 kg	35 kN	2,43 kN/m2	4,78 kN/m2
XTJ 32/R			32 m	14,3 m	330 kg*	660°	180x70 cm	90°+80°	2,82-4,76 m	16%	38%	1,2 km/h	5940 kg	35 kN	2,43 kN/m2	4,78 kN/m2

Available power options:

- BI-ENERGY (DIESEL+AC)
- ECO (AC+BATTERY)

Characteristics and technical data are informative only and subjected to change without notice.

Palazzani Industrie S.p.A.  
Via del Pavione, 4 - 25050 - Paderno F.C. (BS) - Italy  
Tel. (+39) 0306857073  
info@palazzani.it  
www.palazzani.it



NC 836 A 22